

PLAN

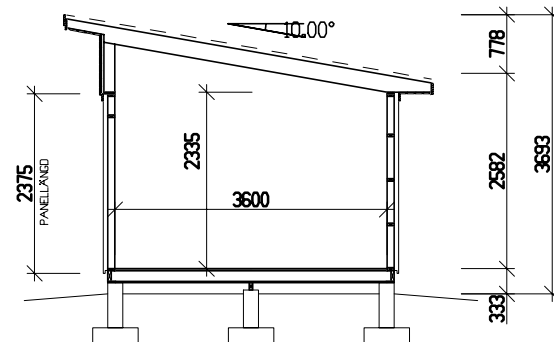

SEKTION

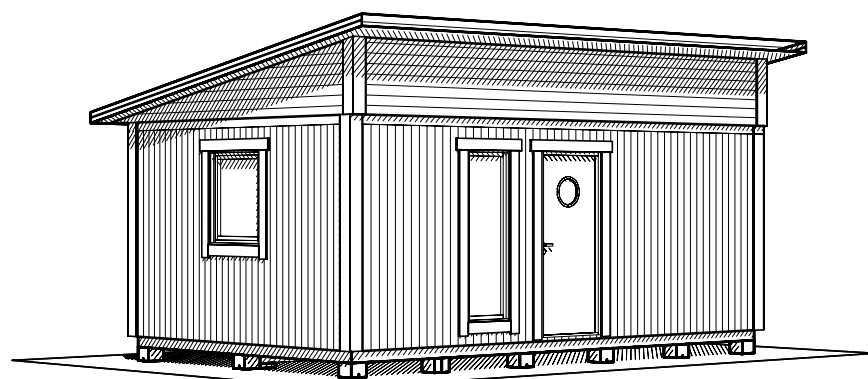

PERSPEKTIV

PANEL: FUNKISPANEL 22x120.  
 STOMME: 34x95.  
 OISLERAT.  
 BJÄLKLAG 45x145.  
 GRUNDLÄGGNING: PLINT GRUND.  
 LEVERANSOMFATTNING ENLIGT AVTAL.

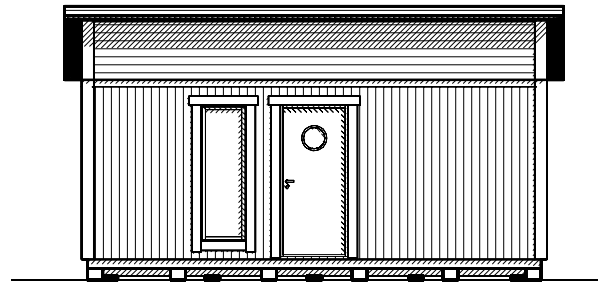

FASAD MOT

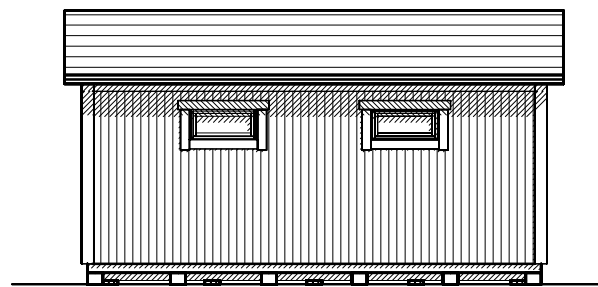

FASAD MOT

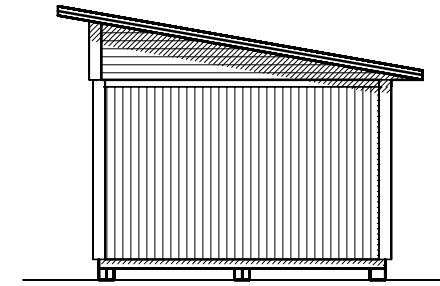

FASAD MOT

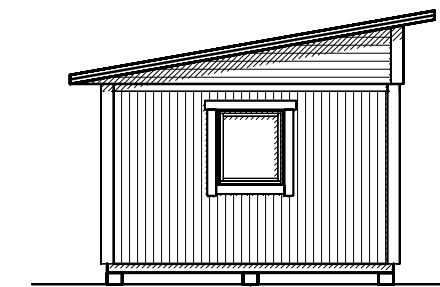

FASAD MOT

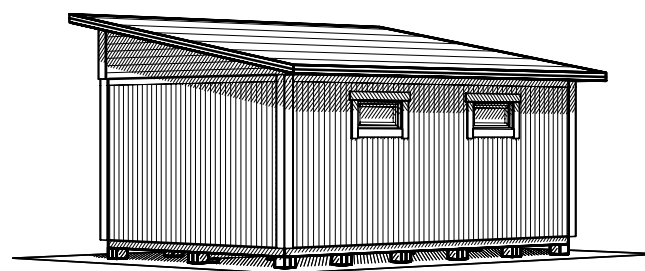

BET	ANT	ÄNDRINGEN AVSER	DATUM	SIGN
<b>BYGGLOVSHANDLING</b>				
NYBYGGNAD AV KOMPLEMENTBYGGNAD				
 <b>VIBO</b>			PLAN & SEKTION NJUTA FUNKIS 25-1	
UPPDRAG NR/RITN. NR		RITAD/KONSTR AV		
XXXX		PH		
DATUM		HANDLÄGGARE		
2018-11-02				
ANSVARIG		SKALA	NUMER	BET
		1:100, A3	A01	